

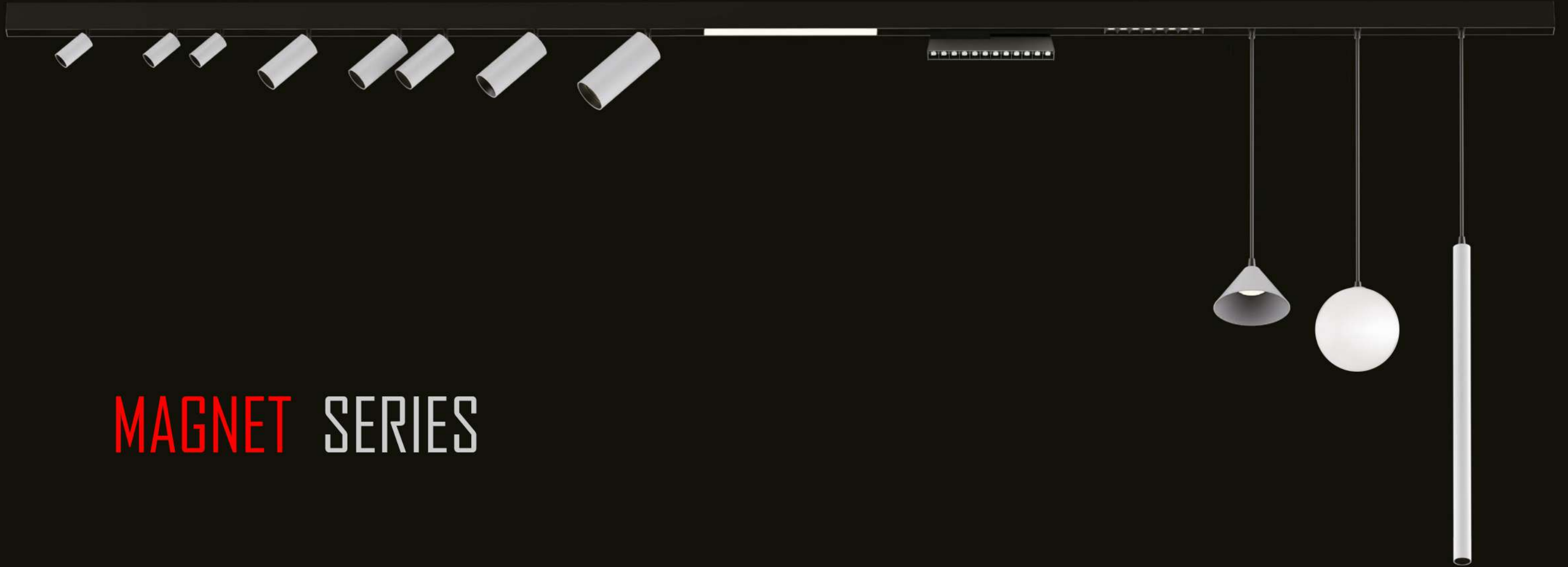

hLite

MAGNET & FRAME  
SERIES  
"20



MAGNET SERIES

Recessed

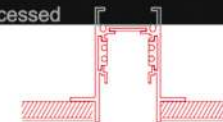

Surface Mounted

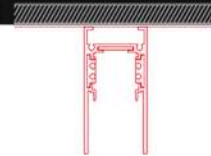

Pendant

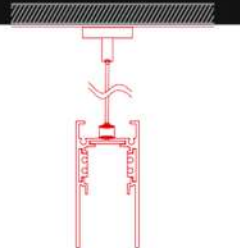

Trak Kurulum Yöntemleri / Track Installation Methods

**SARKIT**  
**PENDANT**

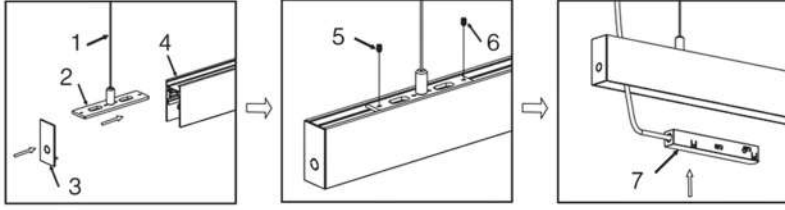

- |                       |  |                   |
|-----------------------|--|-------------------|
| 1- Askı Teli          |  | Suspension Wire   |
| 2- Montaj plakası     |  | Mounting Plate    |
| 3- Yan Kapak          |  | Side Cover        |
| 4- Ray                |  | Track             |
| 5- Vida               |  | Screw             |
| 6- Vida               |  | Screw             |
| 7- DC Bağlantı Kutusu |  | DC Connecting Box |

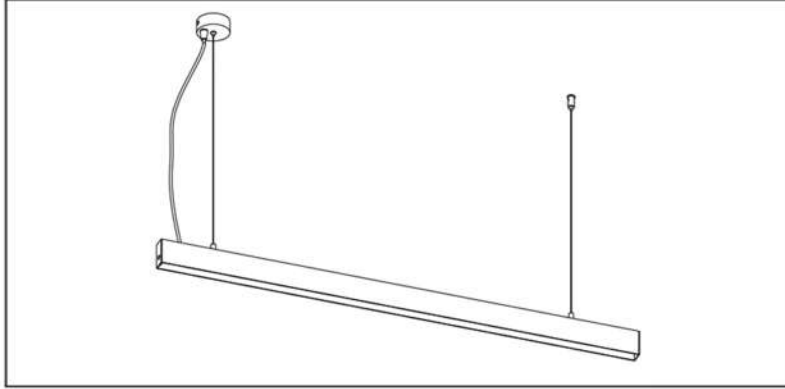

**SIVAÜSTÜ**  
**SURFACE**

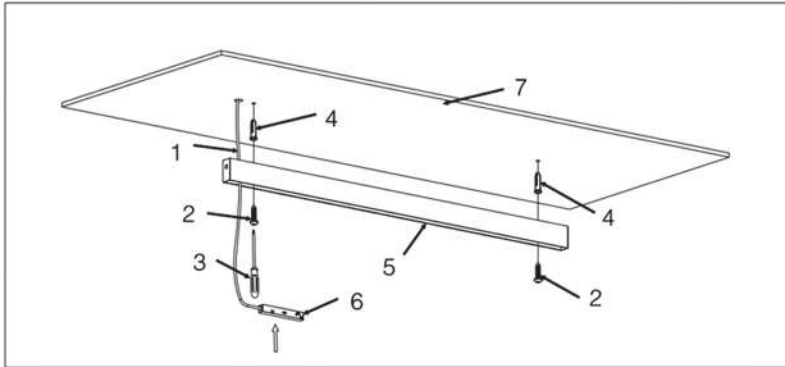

- |                       |  |                   |
|-----------------------|--|-------------------|
| 1- DC 48V Girişi      |  | DC 48V Input      |
| 2- Vida               |  | Screw             |
| 3- Tornavida          |  | Screw Driver      |
| 4- Genleşme Vidası    |  | Expansion Screw   |
| 5- Ray                |  | Track             |
| 6- DC Bağlantı Kutusu |  | DC Connecting Box |
| 7- Tavan              |  | Ceiling           |

**SIVAALTI**  
**RECESSED**

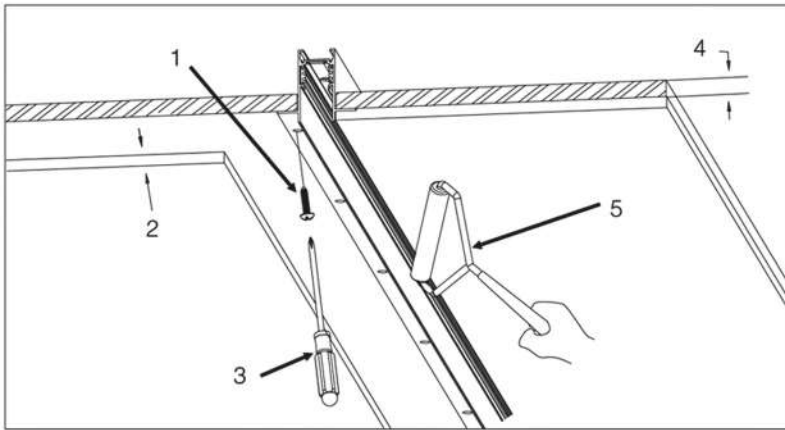

- |                     |  |                       |
|---------------------|--|-----------------------|
| 1- Vida             |  | Screw                 |
| 2- 9 <Alçıpan <12mm |  | 9< Gypsum Board <12mm |
| 3- Tornavida        |  | Screw Driver          |
| 4- Atel Tavan >12mm |  | Splint Ceiling >12mm  |
| 5- Sıvama           |  | Plastering            |

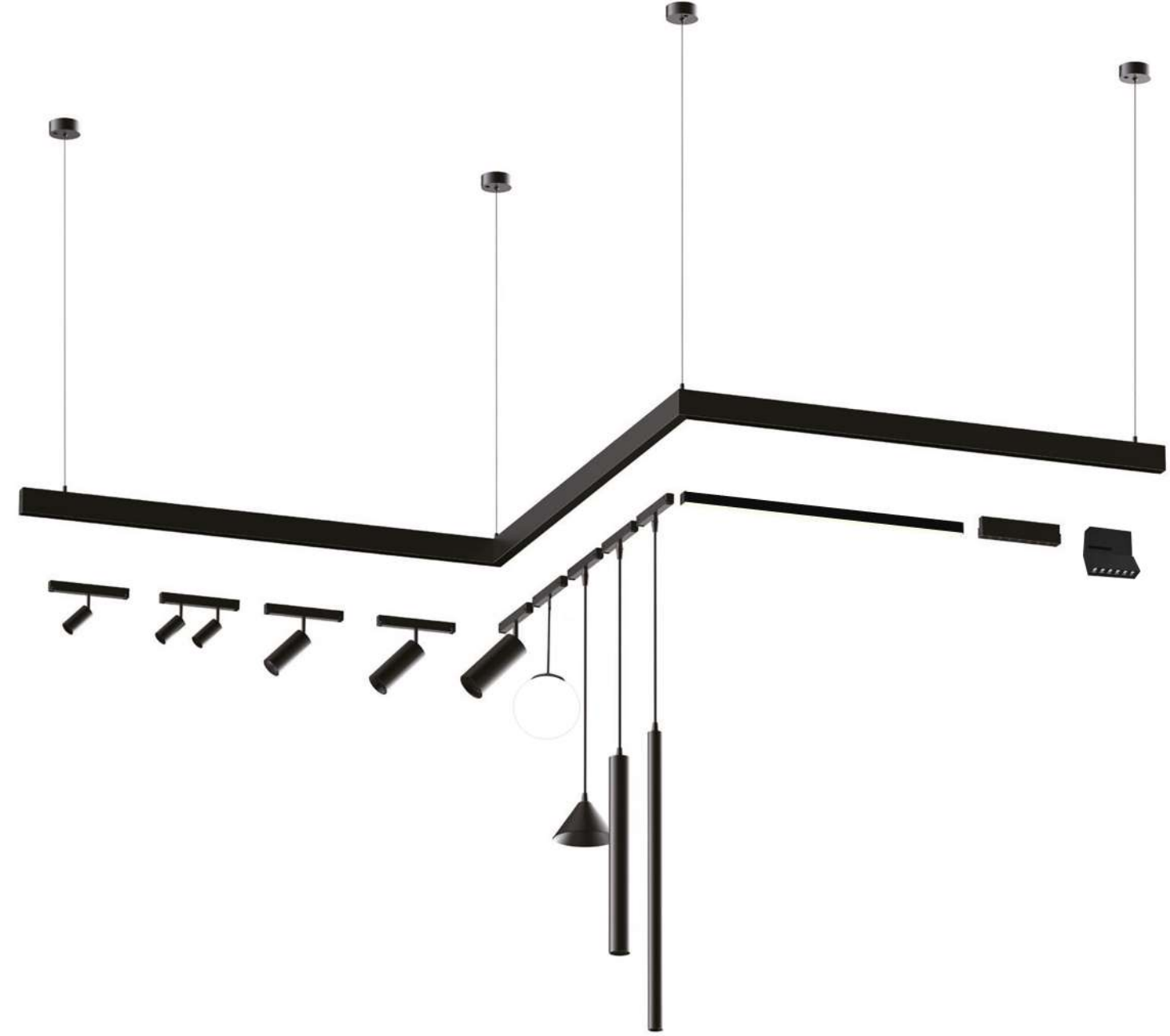

Özellikleri / Features

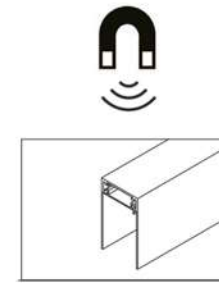

Mıknatıs Sistem  
Magnet System

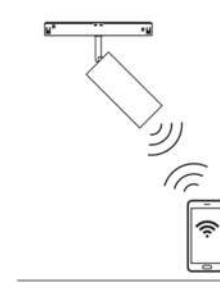

WiFi Teknolojisi  
WiFi Technology

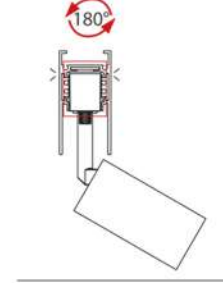

Çift Yönlü Kurulum  
Bidirectional Installation



## MG-HLT-D Series

SMD POWER LED  
 DC 24V - DC48V Input Voltage  
 IP40  
 Beam Angle: 15° - 30° - 45°  
 Lamp Life: 50.000h  
 2700K - 3000K - 4000K  
 CRI: >90  
 TRIAC / DALI / 0-10V / 1-10V / PWM Control Type



### MG-HLT-D5

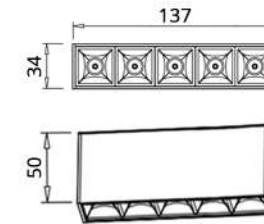

Source Type: SMD  
 Lamp Load: 5W - 10W  
 Input Voltage: DC 24V - DC48V  
 Output Lumens: 500Lm(3000K)  
 Beam Angle: 15° - 30° - 45°  
 CCT: 2700K - 3000K - 4000K  
 Lamp Life: 50.000h  
 Size: 34x50x137mm

### MG-HLT-D5

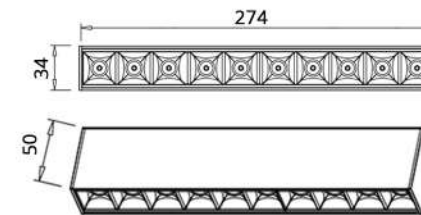

Source Type: SMD  
 Lamp Load: 10W - 20W  
 Input Voltage: DC 24V - DC48V  
 Output Lumens: 500Lm(3000K)  
 Beam Angle: 15° - 30° - 45°  
 CCT: 2700K - 3000K - 4000K  
 Lamp Life: 50.000h  
 Size: 34x50x274mm

### MG-HLT-D15

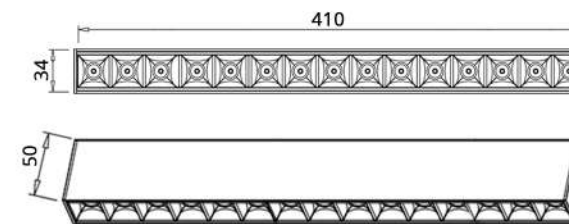

Source Type: SMD  
 Lamp Load: 15W - 30W  
 Input Voltage: DC 24V - DC48V  
 Output Lumens: 500Lm(3000K)  
 Beam Angle: 15° - 30° - 45°  
 CCT: 2700K - 3000K - 4000K  
 Lamp Life: 50.000h  
 Size: 34x50x410mm





## MG-HLT-DA Series

SMD POWER LED  
 DC 24V - DC48V Input Voltage  
 IP40  
 Beam Angle: 15° - 30° - 45°  
 Lamp Life: 50.000h  
 2700K - 3000K - 4000K  
 CRI: >90  
 TRIAC / DALI / 0-10V / 1-10V / PWM Control Type



### MG-HLT-DA5

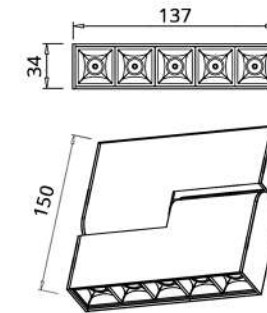

Source Type: SMD  
 Lamp Load: 5W - 10W  
 Input Voltage: DC 24V - DC48V  
 Output Lumens: 500Lm(3000K)  
 Beam Angle: 15° - 30° - 45°  
 CCT: 2700K - 3000K - 4000K  
 Lamp Life: 50.000h  
 Size: 34x150x137mm

### MG-HLT-DA10

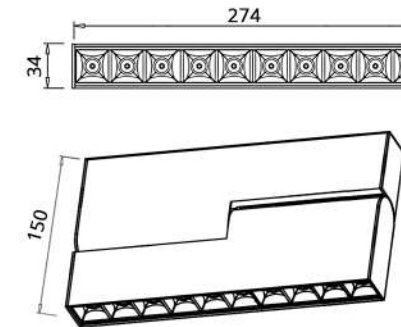

Source Type: SMD  
 Lamp Load: 10W - 20W  
 Input Voltage: DC 24V - DC48V  
 Output Lumens: 500Lm(3000K)  
 Beam Angle: 15° - 30° - 45°  
 CCT: 2700K - 3000K - 4000K  
 Lamp Life: 50.000h  
 Size: 34x150x274mm

### MG-HLT-DA15

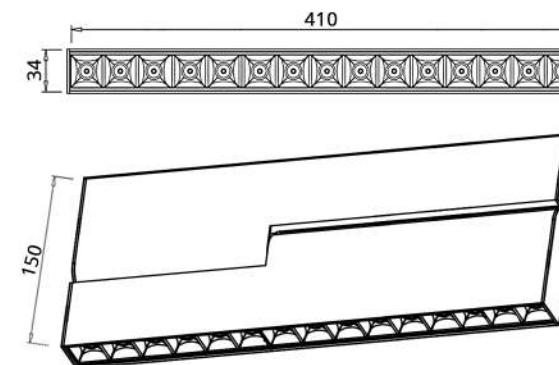

Source Type: SMD  
 Lamp Load: 15W - 30W  
 Input Voltage: DC 24V - DC48V  
 Output Lumens: 500Lm(3000K)  
 Beam Angle: 15° - 30° - 45°  
 CCT: 2700K - 3000K - 4000K  
 Lamp Life: 50.000h  
 Size: 34x150x410mm



## MG-HLT-L -Series

SMD POWER LED  
 DC 24V - DC48V Input Voltage  
 IP40  
 Beam Angle: 120°  
 Lamp Life: 50.000h  
 2700K - 3000K - 4000K  
 CRI: >90  
 TRIAC / DALI / 0-10V / 1-10V / PWM Control Type

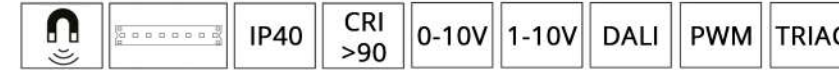

### MG-HLT-L137

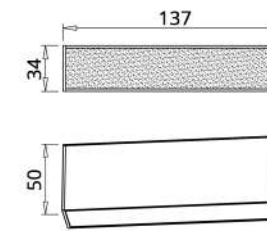

Source Type: SMD  
 Lamp Load: 5W - 10W  
 Input Voltage: DC 24V - DC48V  
 Output Lumens: 500Lm(3000K)  
 Beam Angle: 15° - 30° - 45°  
 CCT: 2700K - 3000K - 4000K  
 Lamp Life: 50.000h  
 Size: 34x50x137mm

### MG-HLT-L405

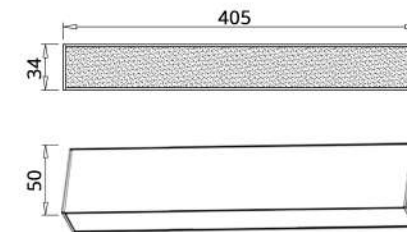

Source Type: SMD  
 Lamp Load: 10W - 20W  
 Input Voltage: DC 24V - DC48V  
 Output Lumens: 500Lm(3000K)  
 Beam Angle: 15° - 30° - 45°  
 CCT: 2700K - 3000K - 4000K  
 Lamp Life: 50.000h  
 Size: 34x50x405mm

### MG-HLT-L675

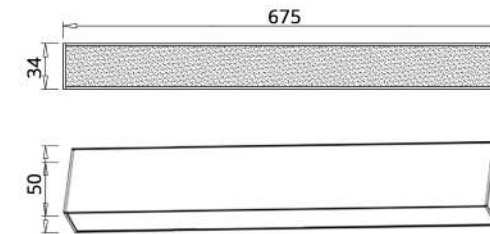

Source Type: SMD  
 Lamp Load: 15W - 30W  
 Input Voltage: DC 24V - DC48V  
 Output Lumens: 500Lm(3000K)  
 Beam Angle: 15° - 30° - 45°  
 CCT: 2700K - 3000K - 4000K  
 Lamp Life: 50.000h  
 Size: 34x50x675mm

### MG-HLT-L945

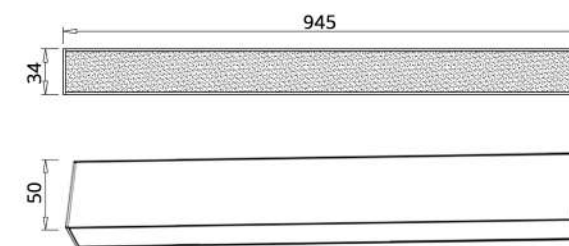

Source Type: SMD  
 Lamp Load: 30W - 40W  
 Input Voltage: DC 24V - DC48V  
 Output Lumens: 500Lm(3000K)  
 Beam Angle: 15° - 30° - 45°  
 CCT: 2700K - 3000K - 4000K  
 Lamp Life: 50.000h  
 Size: 34x50x945mm





## MG-HLT-S Series

SMD POWER LED & COB LED  
 DC 24V - DC48V Input Voltage  
 IP40  
 Beam Angle: 15° - 30° - 45°  
 Lamp Life: 50.000h  
 2700K - 3000K - 4000K  
 CRI: >90  
 TRIAC / DALI / 0-10V / 1-10V / PWM Control Type



### MG-HLT-S25

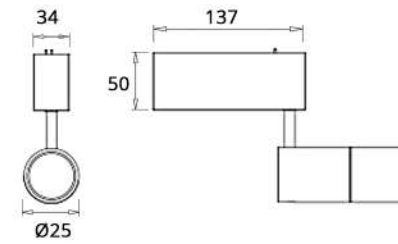

Source Type: SMD  
 Lamp Load: 3W  
 Input Voltage: DC 24V - DC48V  
 Output Lumens: 500Lm(3000K)  
 Beam Angle: Wallwasher  
 CCT: 2700K - 3000K - 4000K  
 Lamp Life: 50.000h  
 Size: 34x50x137mm

### MG-HLT-S35

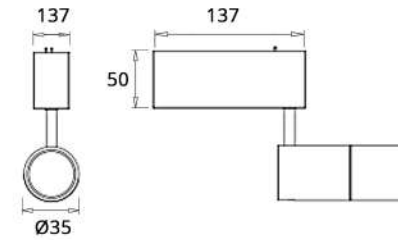

Source Type: SMD  
 Lamp Load: 5W  
 Input Voltage: DC 24V - DC48V  
 Output Lumens: 500Lm(3000K)  
 Beam Angle: Wallwasher  
 CCT: 2700K - 3000K - 4000K  
 Lamp Life: 50.000h  
 Size: 34x50x137mm

### MG-HLT-S50

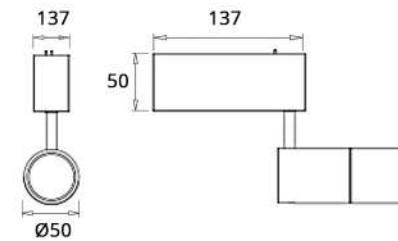

Source Type: COB  
 Lamp Load: 10W  
 Input Voltage: DC 24V - DC48V  
 Output Lumens: 500Lm(3000K)  
 Beam Angle: Wallwasher  
 CCT: 2700K - 3000K - 4000K  
 Lamp Life: 50.000h  
 Size: 34x50x137mm

### MG-HLT-S60

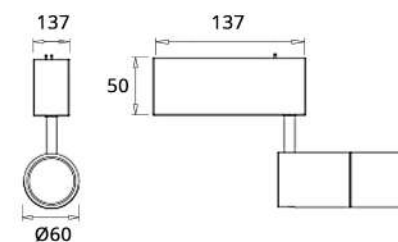

Source Type: COB  
 Lamp Load: 15W  
 Input Voltage: DC 24V - DC48V  
 Output Lumens: 500Lm(3000K)  
 Beam Angle: Wallwasher  
 CCT: 2700K - 3000K - 4000K  
 Lamp Life: 50.000h  
 Size: 34x50x137mm



## MG-HLT-SS Series

SMD POWER LED  
 DC 24V - DC48V Input Voltage  
 IP40  
 Beam Angle: 15° - 30° - 45°  
 Lamp Life: 50.000h  
 2700K - 3000K - 4000K  
 CRI: >90  
 TRIAC / DALI / 0-10V / 1-10V / PWM Control Type

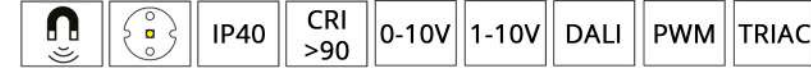

## MG-HLT-SS25

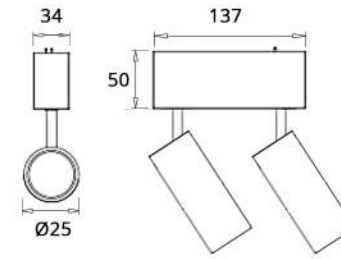

Source Type: SMD  
 Lamp Load: 2\*3W  
 Input Voltage: DC 24V - DC48V  
 Output Lumens: 500Lm(3000K)  
 Beam Angle: Wallwasher  
 CCT: 2700K - 3000K - 4000K  
 Lamp Life: 50.000h  
 Size: 34x50x137mm

## MG-HLT-SS35

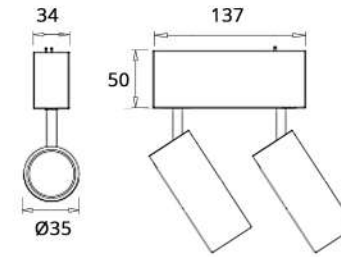

Source Type: SMD  
 Lamp Load: 2\*5W  
 Input Voltage: DC 24V - DC48V  
 Output Lumens: 500Lm(3000K)  
 Beam Angle: Wallwasher  
 CCT: 2700K - 3000K - 4000K  
 Lamp Life: 50.000h  
 Size: 34x50x137mm





## MG-HLT-FC Series

COB LED  
 DC 24V - DC48V Input Voltage  
 IP40  
 Beam Angle: 15° ~ 60° focus  
 Lamp Life: 50.000h  
 2700K - 3000K - 4000K  
 CRI: >90  
 TRIAC / DALI / 0-10V / 1-10V / PWM Control Type

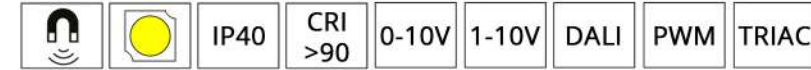

## MG-HLT-FC90

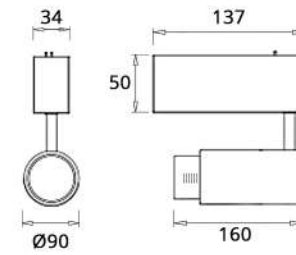

Source Type: COB  
 Lamp Load: 15W - 20W  
 Input Voltage: DC 24V - DC48V  
 Output Lumens: 500Lm(3000K)  
 Beam Angle: Wallwasher  
 CCT: 2700K - 3000K - 4000K  
 Lamp Life: 50.000h  
 Size: Ø90x160x170mm

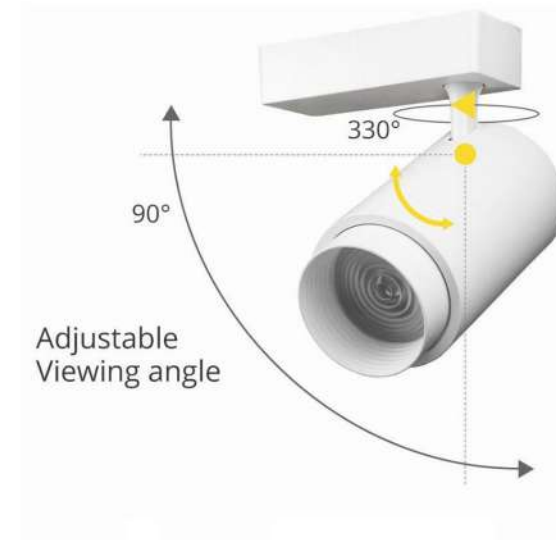







## MG-HLT-L Series

SMD POWER LED  
 DC 24V - DC48V Input Voltage  
 IP40  
 Beam Angle: 90°  
 Lamp Life: 50.000h  
 2700K - 3000K - 4000K  
 CRI: >90  
 TRIAC / DALI / 0-10V / 1-10V / PWM Control Type



### MG-HLT-L01

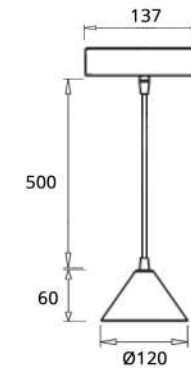

Source Type: SMD  
 Lamp Load: 5W  
 Input Voltage: DC 24V - DC48V  
 Output Lumens: 500Lm(3000K)  
 Beam Angle: 90°  
 CCT: 2700K - 3000K - 4000K  
 Lamp Life: 50.000h  
 Size: Ø120x60x500x137mm

### MG-HLT-L02

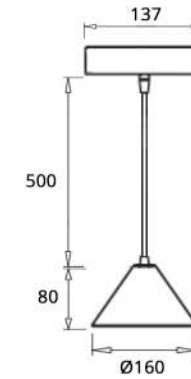

Source Type: SMD  
 Lamp Load: 7W  
 Input Voltage: DC 24V - DC48V  
 Output Lumens: 500Lm(3000K)  
 Beam Angle: 90°  
 CCT: 2700K - 3000K - 4000K  
 Lamp Life: 50.000h  
 Size: Ø160x80x500x137mm

### MG-HLT-L03

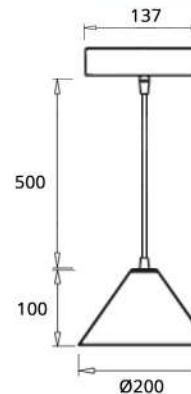

Source Type: SMD  
 Lamp Load: 12W  
 Input Voltage: DC 24V - DC48V  
 Output Lumens: 500Lm(3000K)  
 Beam Angle: 90°  
 CCT: 2700K - 3000K - 4000K  
 Lamp Life: 50.000h  
 Size: Ø200x100x500x137mm



## MG-HLT-B Series

SMD POWER LED  
 DC 24V - DC48V Input Voltage  
 IP40  
 Lamp Life: 50.000h  
 2700K - 3000K - 4000K  
 CRI: >90  
 TRIAC / DALI / 0-10V / 1-10V / PWM Control Type

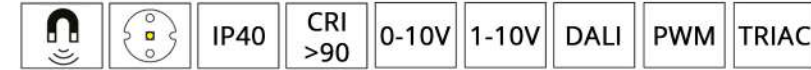

### MG-HLT-B01

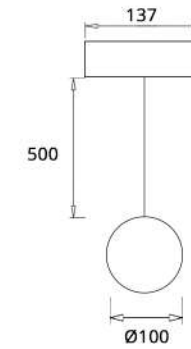

Source Type: SMD  
 Lamp Load: 3W  
 Input Voltage: DC 24V - DC48V  
 Output Lumens: 500Lm(3000K)  
 CCT: 2700K - 3000K - 4000K  
 Lamp Life: 50.000h  
 Size: Ø100x500x137mm

### MG-HLT-B02

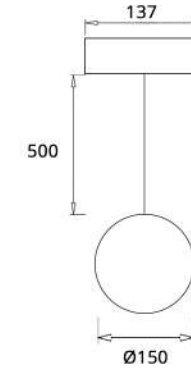

Source Type: SMD  
 Lamp Load: 6W  
 Input Voltage: DC 24V - DC48V  
 Output Lumens: 500Lm(3000K)  
 CCT: 2700K - 3000K - 4000K  
 Lamp Life: 50.000h  
 Size: Ø150x500x137mm

### MG-HLT-B03

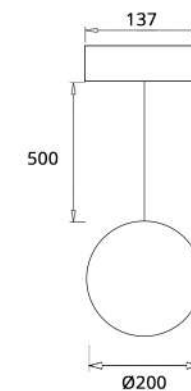

Source Type: SMD  
 Lamp Load: 10W  
 Input Voltage: DC 24V - DC48V  
 Output Lumens: 500Lm(3000K)  
 CCT: 2700K - 3000K - 4000K  
 Lamp Life: 50.000h  
 Size: Ø200x500x137mm



